



**Absolutely, positively, the best
automatic inground pool cleaner!**



www.pentairpool.com

© 2011 Pentair Water Pool and Spa, Inc. All rights reserved.

1620 Hawkins Ave., Sanford, NC 27330
(800) 831-7133 • (919) 566-8000
10951 West Los Angeles Ave., Moorpark, CA 93021
(800) 831-7133 • (805) 553-5000

Kreepy Krauly®, and Pentair Water Pool and Spa® are trademarks and/or registered trademarks of Pentair Water Pool and Spa, Inc. and/or its affiliated companies in the United States and/or other countries. Unless noted, names and brands of others that may be used in this document are not used to indicate an affiliation or endorsement between the proprietors of these names and brands and Pentair Water Pool and Spa, Inc. Those names and brands may be the trademarks or registered trademarks of those parties or others.
Part Number #K0130 Rev C. 1/24/11

Installation and Operation Manual

Welcome

Congratulations on purchasing the best pool-cleaning system in the world! Your new Kreepy Krauly will provide you with years of carefree pool enjoyment, as it efficiently vacuums your pool for you. Before long, you'll wonder how you ever got along without Kreepy Krauly.

First, however, you'll have to install Kreepy Krauly and perhaps make some minor adjustments. This manual covers the steps needed to install and adjust Kreepy Krauly.

Contents

I.	Pool Preparation	3
II.	Assembly	3
III.	Installation	6
	- Standard pool installation.....	6
	- Non-standard pool installations.....	7
IV.	Adjustments.....	8-9
V.	Troubleshooting.....	10-12
VI.	Kreepy Krauly Parts, Hose and Accessories	13
VII.	Maintenance.....	14
VIII.	Customer Service.....	14

Please record the serial number of your Kreepy Krauly in the space below. This way, if you need to refer to the serial number in the future (e.g. if you call the Customer Helpline), it will be readily available. The diagram on page 3 shows where Kreepy Krauly's serial number is located.

Kreepy Krauly Serial Number _____

Activate Kreepy Krauly's Warranty

You will also need to record this serial number on Kreepy Krauly's warranty registration card. Complete and return the card to activate Kreepy Krauly's warranty. The registration card is self-addressed and postage-paid for your convenience.

Toll-free Customer Helpline

If you have questions about your Kreepy Krauly, check the instructions in this manual or view the included installation video. If you still have a question, call our Customer Helpline at 1-800-443-5711. Please have your Kreepy Krauly serial number ready when you call.

Warranty Note







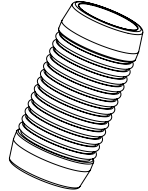

Cleaners purchased in the United States of America from entities outside the United States do not qualify for any United States programs including warranty, trade-in, or rebate programs.

10-Day Money-Back Guarantee at Participating Dealers

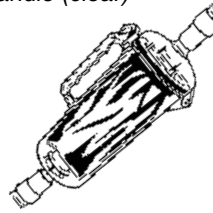
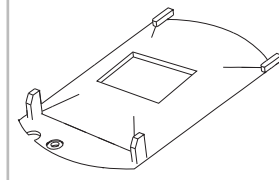
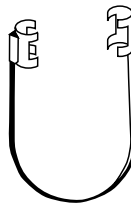
We are so sure you'll be satisfied with the way your new Kreepy Krauly cleans your pool, that we offer a special money-back guarantee at participating dealers. Here's how it works:

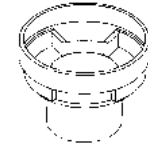
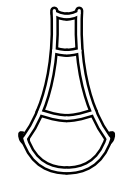
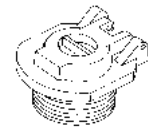
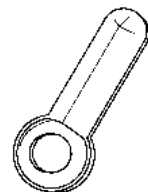
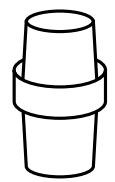
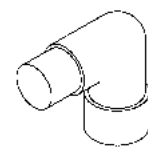
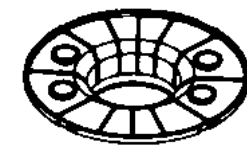
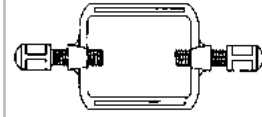
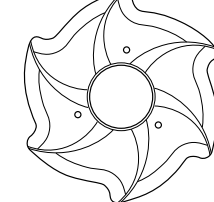
1. Should you have any questions regarding the operation of the cleaner, call your Pentair Pool Products dealer.
2. For additional assistance, call our Customer Helpline at 1-800-443-5711.
3. If you are not completely satisfied, return the Kreepy Krauly (including all the contents in the box), with your proof of purchase to your dealer within 10 days for a full refund.

Kreepy Krauly Hose & Accessories

K01200 COMPLETE VACUUM HOSE ASSEMBLY – BLUE (40 ft. total Length) -11 Sections Male / Female Hose (40") -1 Section Female / Female Hose (40")		K21241B Blue K21241 White 4" Female/Female Hose		K121110 2" Hose Cone	
					
R211084K Leaf Trap with Handle (clear)	K12182 Baffle Plate	K12330 Ladder Guard	K12173 Bumper End Clip	K12465 Hose Protector	
					
K12094 Manual By-pass for Automatic Regulator Valve	K12065 Wall Climb Adjuster	GW9530 Snap-Lock Wall Fitting	K3349 Vac Line Deflector	K121240 Hose Connector	
					
K12097 90° Hose Connector	K12068 Vac Plus II Plate 7/4"	K12076 Vac Plus II Locking Bar	K12895 Starfish Seal (For Concrete Pools Only)	K12078 45° Hose Connector	
					
	K121620 Wire Diverter	K121683 Eyeball Diverter Outer Ring	K121680 Eyeball Diverter		
					

VII. Maintenance

Kreepy Krauly requires almost no maintenance. Visually inspect your Kreepy Krauly from time to time to make sure that:

- The flapper is moving freely and is not obstructed by debris.
- The foot pad is not excessively worn. When the traction pads on the bottom have worn down, it is time for replacement.

We recommend that you leave Kreepy Krauly in your pool, **except during chemical shock treatments.** During swimming it is easy to unplug Kreepy Krauly and pull it to one side.

When storing Kreepy Krauly, do not coil the hose. Lay the hose flat in an area protected from direct sunlight. If hose sections are disconnected, try not to disturb the hose weight locations.

Kreepy Krauly's hose is specially designed to ensure optimum performance from Kreepy Krauly. Should replacement be required, insist on genuine Kreepy Krauly hose.

VIII. Customer Service

Your satisfaction is important to us, so we're happy to help you get the best performance possible from your new Kreepy Krauly. This manual and the video included with your Kreepy Krauly cover a wide range of performance adjustments, which may apply to your pool.

If you still need help, call your Pentair Pool Products dealer or call our toll-free Customer Helpline at 1-800-443-5711. Please have your Kreepy Krauly serial number ready when you call.

Disclaimer of Liability – About Your Pool and Kreepy Krauly

There are a multitude of factors that contribute to the life of your pool. The Kreepy Krauly automatic pool cleaner is a very passive product that will have no impact on pool life.

Please be aware that over time, deterioration, discoloration and brittleness of any pool finish can be caused separately by, or in combination with, age, an imbalance in pool water chemistry, improper installation and other factors. An automatic pool cleaner, such as Kreepy Krauly, will not remove or cause wear on "good" pool plaster. In fact, the opposite is true—pool plaster will eventually cause wear on the cleaner.

The same situation holds true for vinyl-lined inground swimming pools, because vinyl liners are also affected by the environment and factors such as pool water chemistry, sunlight and the pool's surroundings. Therefore over time, vinyl can become brittle and weak. In addition, vinyl-lined pools are affected by the workmanship, composition and installation of the liner and the workmanship and quality of construction of the supporting walls and pool base. These are all factors which can contribute to liner failure. The existence of any of these type of conditions in your pool is not caused by the use or operation of Kreepy Krauly. The manufacturer disclaims any liability for repairs or replacement to any of these structures or components of the customer's pool.

The pool owner must assume all responsibility for the condition and maintenance of the pool's surface, water and deck.

I. Preparation Of Your Pool

Before assembling and installing your Kreepy Krauly, your pool should be clean and algae-free so as not to inhibit the cleaner's traction. If necessary, make the following preparations before proceeding:

1. Chemically balance the pool water.
2. Brush pool and let the debris settle.
3. Hand vacuum thoroughly.
4. Clean filter and pump strainer basket.

II. Assembly

Remove Kreepy Krauly and all of its parts from the box and check to make sure that all components were included. Refer to Figure 1.

Components Check List

1. Dive float restrictor
2. Kreepy Krauly
3. Locking end clip
4. Roller bumper strap
5. Hose weights
6. Wings
7. Eyeball diverter and outer ring
8. Hose Protector
9. Valve cap
10. Automatic regulator valve
11. Threaded compression adapter
12. Pleated or Starfish seal
13. Hose – 40 ft. total length (not shown)
14. Installation manual (not shown)

Figure 1

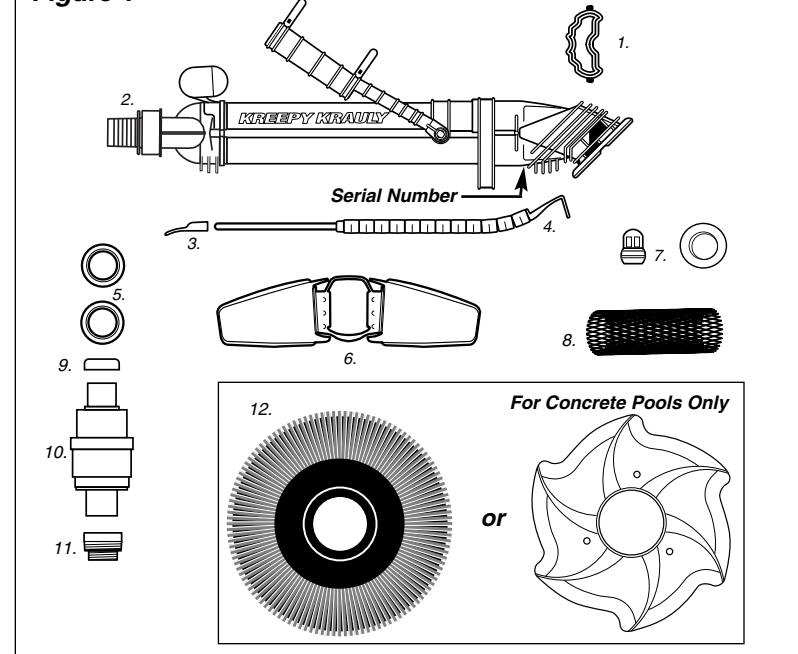

Step 1. Attach The Wings

Kreepy Krauly's wings snap into place – no tools are needed. Position the wings so you bring the band around the main body as shown in Figure 2. Slip the wings into the groove in Kreepy Krauly's main body, then snap the band clamp into place.

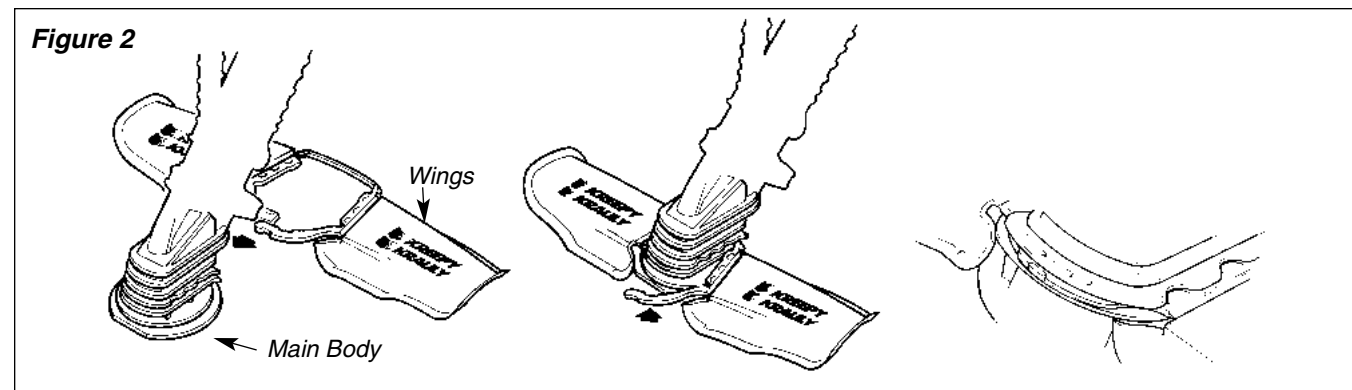

Step 2. Attach The Seal

Your Kreepy Krauly comes equipped with one of two seals. The Pleated seal is our universal seal and works in **all** pool types: concrete, vinyl, fiberglass, and tile. And our Starfish seal which is used exclusively in concrete pools only.

To install either seal locate the words “**This Side Up**” and face them towards the main body. Slip the seal over the footpad – (flat side down towards pool floor) and pull gently until it seats itself on the other side in its groove, as illustrated in Figure 3. **The seal must be installed flat side down, pleated/contoured side up.** Once in place, the seal should rotate and turn freely.

The seals are not reversible. The raised pleats on the Pleated seal and the contours on the Starfish seal must face upward. The flat side of the seal should face down to rest against the pool surface.

Step 3. Attach The Roller Bumper Strap

Insert the bottom end of the strap into the slot provided on the main body. Insert the top end of the strap into the locking clip attached to the swivel head. See Figure 4.

Step 4. Attach The Dive Float Restrictor

Snap the dive float restrictor into the lower U-shaped brace between the dive floats. Make sure the locking tabs on both sides of the dive float restrictor snap securely into place. See Figure 5.

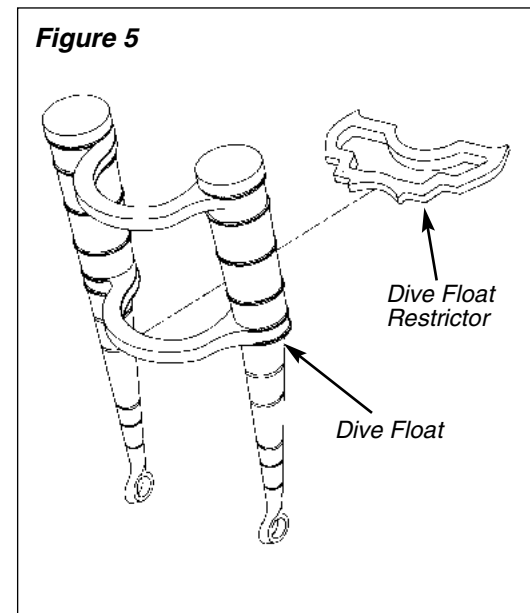
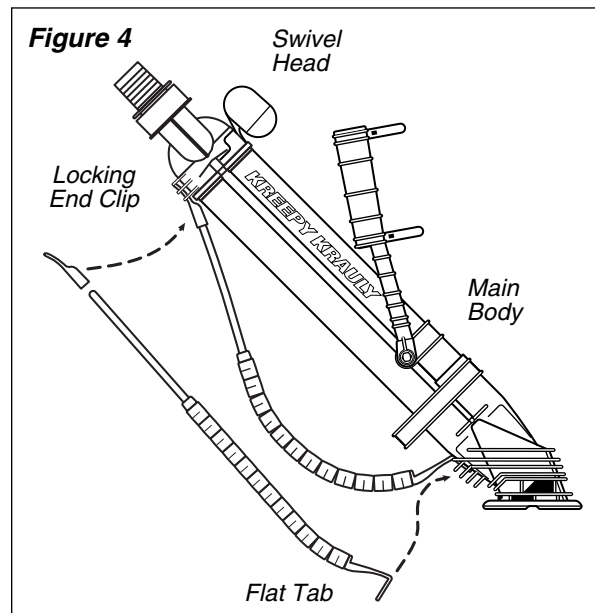
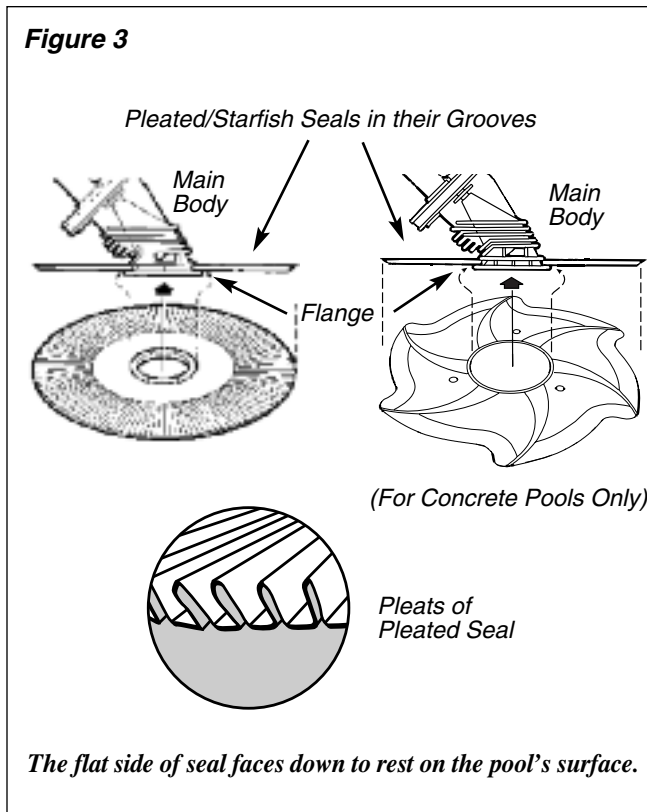

VI. Kreepy Krauly Parts List

“Insist on Genuine Kreepy Krauly Parts To Protect Your Warranty”

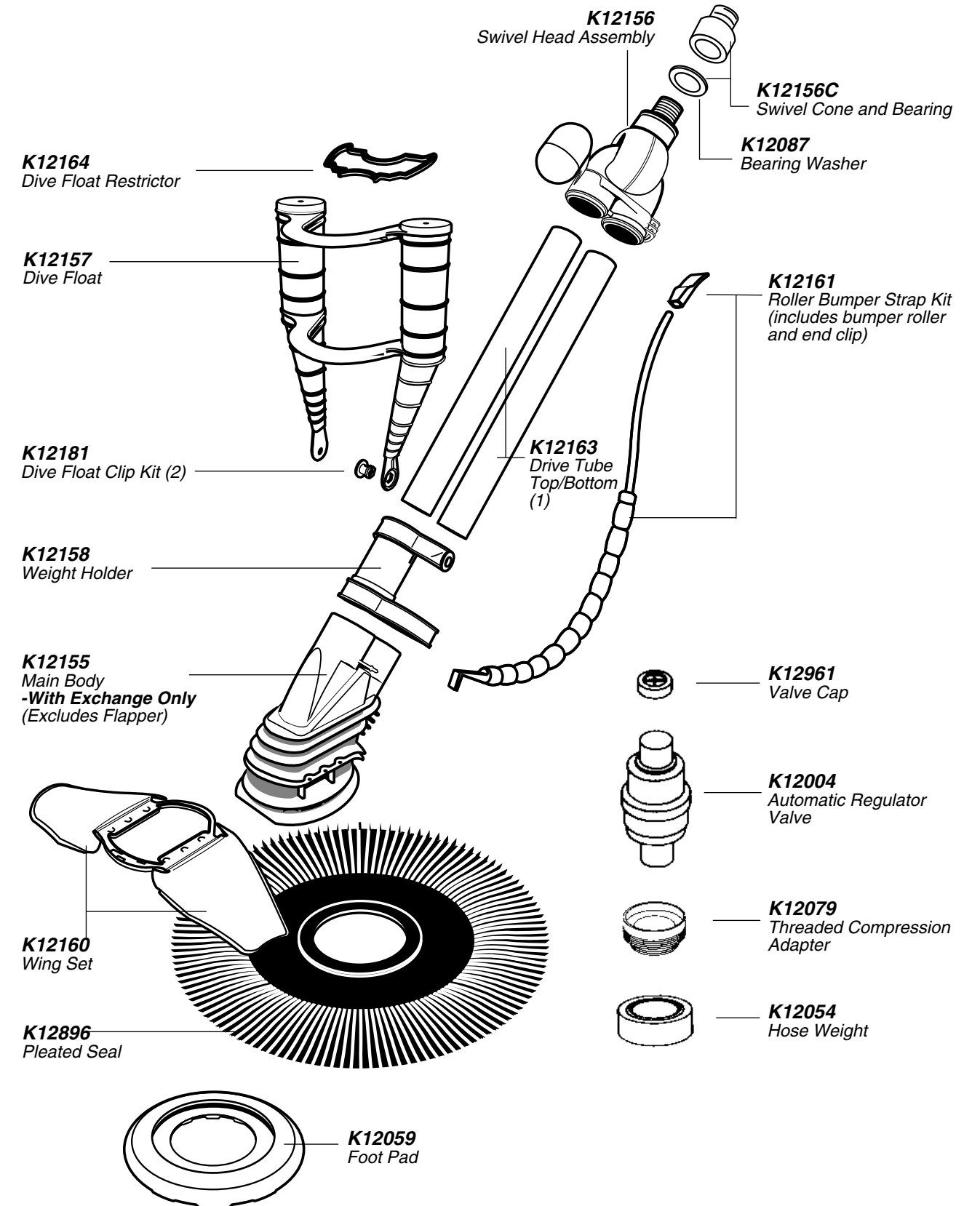

If Kreepy Krauly tracks in a repetitive pattern.

- Check the swivel on the top of Kreepy Krauly. It should turn freely.
- Check the return line water flow and re-direct as necessary with an eyeball diverter. Refer to page 9.
- Check Kreepy Krauly's hose to ensure it has not become bent or kinked. It only takes one bent or kinked hose section to hinder the cleaning coverage. One way to check for kinks in your hose is to lay each section flat on your pool's deck (or other flat surface). The hose should be perfectly straight and flat. **Do not coil the hose when taking your Kreepy Krauly out of the pool because it will retain the coil shape, forming a bend or kink.**

If Kreepy Krauly gets stuck on pool obstructions such as a safety ledge, ladders, steps, swim-outs, benches, etc.

- Remove dive float restrictor and install a wall climb adjuster (Part #K12065). Snap the wall climb adjuster into place as shown in Figure 17. This will keep Kreepy Krauly on the pool's floor and away from pool obstructions. Make sure the narrow end of the wall climb adjuster points down to the drive tubes.
- If Kreepy Krauly gets stuck under your pool ladder, install a Ladder Guard (Part #K12330) according to the instructions contained in the packaging. (These accessories are available for purchase from your Pentair Pool Products dealer.)

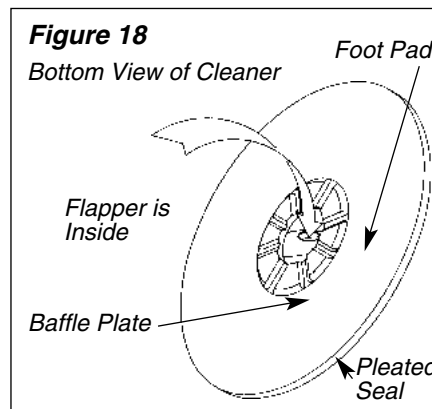
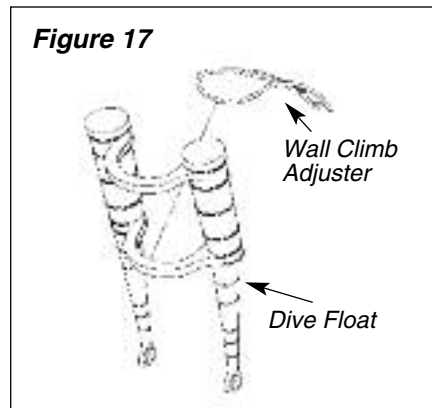

To Remove Debris From The Flapper

- Sometimes debris may clog the bottom of the cleaner and prevent flapper movement or restrict flow. The flapper is located inside the main body and must move freely at all times. You can see the flapper through the opening in the baffle plate, when you turn the cleaner upside down as shown in Figure 18. Jiggle the flapper with your finger or flush the cavity with a hose to force out any debris lodged inside the main body.
- If debris is still lodged inside, you must remove the flapper. First, lift the lip of the foot pad and insert a flat-head screwdriver along side one of the two tabs found on the baffle plate. See Figure 19. Push the tab inward with the screwdriver until the baffle plate releases. Place a finger into the center opening of the baffle plate and pull up until it pops out. Then pull the flapper out. **NOTE: You should be able to do this without taking the foot pad off.**
- Once the debris is dislodged, insert the flapper back into the main body and snap the baffle plate back into position. Be sure that it is securely in place. See Figure 19.

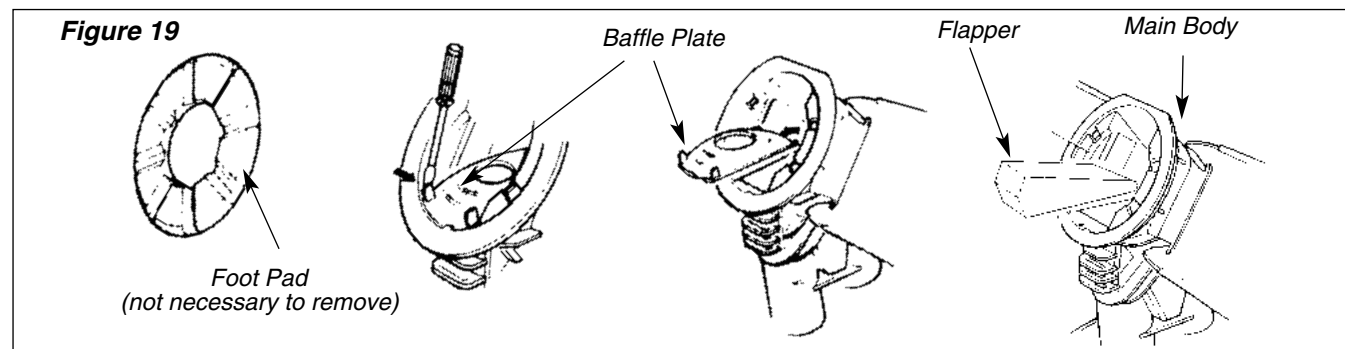

Step 5. Attach The Hose Weights And Assemble The Hose

The Kreepy Krauly hose comes in sections which must be assembled. You'll need enough sections to reach from where Kreepy Krauly is connected, to the farthest part of your pool, plus one section. You will also have to attach hose weights to the hose **to neutralize the hose's buoyancy in water.** The number of hose weights required is determined by the maximum depth of your pool. The deeper your pool, the more weight is needed. The number of hose weights appropriate for your pool is explained in Table A.

Twist and push the female ends onto the male ends after dipping the ends into the pool to wet them. See Figure 6. Continue until you've connected all the sections you need. After connecting the hose weights to the hose as described in "Table A", then connect the hose to Kreepy Krauly. See Figure 7.

One of the hose sections has 2 female ends. This section should be fitted last and attached to the pool's vacuum connection.

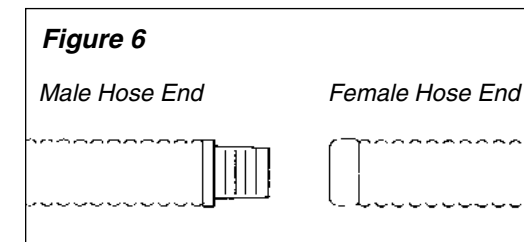

Before attaching the Female/Female Section to your vacuum connection you will first need to install the hose protector on to the Female/Female hose section. The hose protector is used to protect the hose from wear.

NOTE: May substitute 4 inch Female/Female hose.

Your fully assembled Kreepy Krauly should look like this.

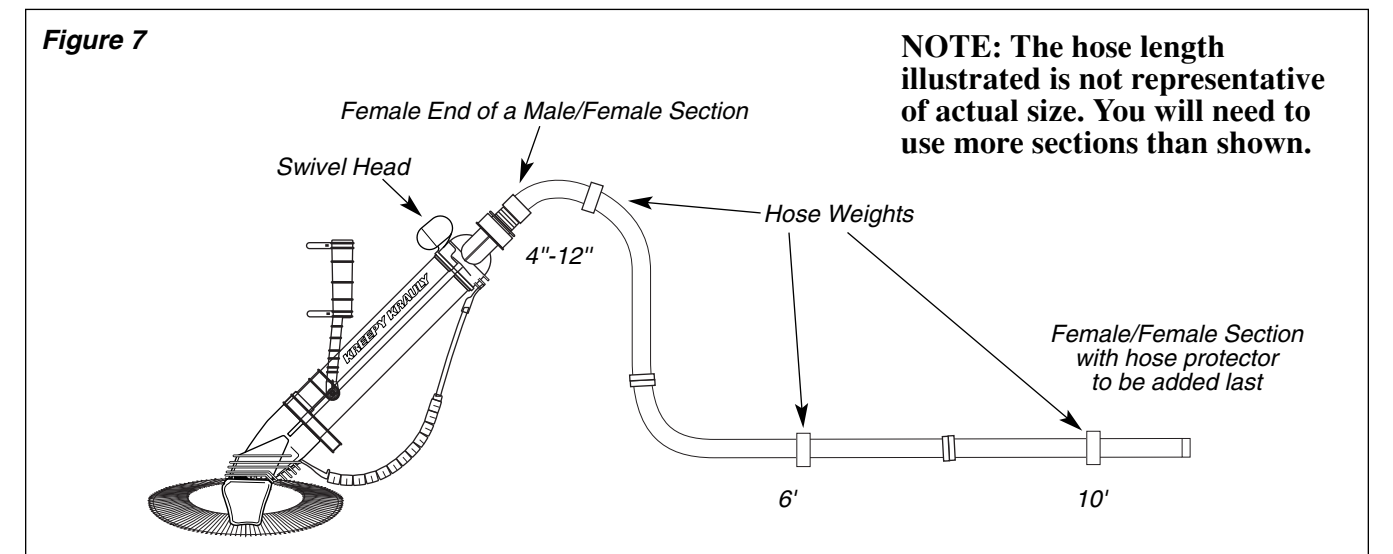

III. Installation

Kreepy Krauly is designed to work in a wide variety of swimming pools. That's why we've included certain items (such as a threaded compression adapter and valve cap for the automatic regulator valve) with your Kreepy Krauly. These may or may not be needed, depending on the particular features of your pool.

Both the standard in-skimmer installation and an optional vacuum line installation are covered in this manual. Check to see which most closely fits your pool configuration and follow the directions. If the set-up of your pool is unlike any of the examples, contact your Pentair Pool Products dealer for assistance or call our toll-free Customer Helpline at 1-800-443-5711.

Standard Installation *For pools with one skimmer, using the automatic regulator valve.*

The advantage of this installation is that the automatic regulator valve automatically balances the water flow between the skimmer and Kreepy Krauly. We strongly recommend the use of the automatic regulator valve for maximum safety and performance. The valve automatically adjusts to changes in the amount of water flow to provide Kreepy Krauly with the power necessary to ensure proper cleaning performance.

1. Turn the pool pump off.
2. Close the main drain and all suction lines, except the line from the skimmer to which Kreepy Krauly will be connected.
3. Remove skimmer basket.
4. Screw the threaded compression adapter into the vacuum connection in the bottom of the skimmer. See Figure 9.
NOTE: Use two wraps of Teflon tape around threads to ensure easy removal.
(If the opening in the bottom of the skimmer is **not** threaded, use a 2" hose cone, as shown in Figure 8. It is not included with your Kreepy Krauly, but can be purchased from your Pentair Pool Products dealer.)
5. Press the automatic regulator valve into the threaded compression adapter. The end of the valve that is marked "Attach Hose This End" must point up. See Figure 9.
6. Place Kreepy Krauly into the pool and allow it to sink to the floor. Continue to feed the hose vertically down into the pool until it is completely filled with water and purged of air.
7. Slide the hose protector into position on the hose to prevent the hose body from rubbing against the skimmer wall. See Figure 9.
8. Insert the end of the hose through the skimmer opening and connect the hose directly onto the automatic regulator valve.

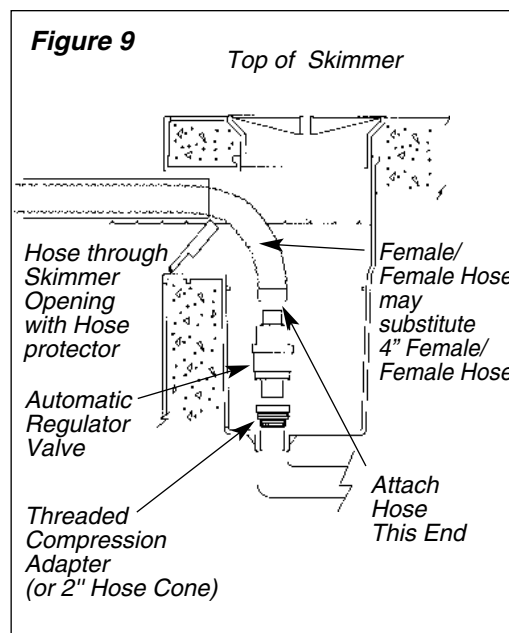
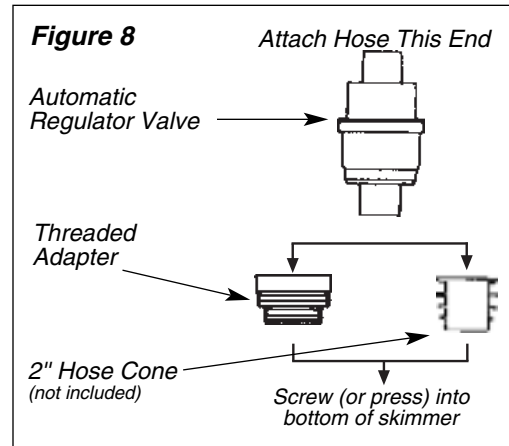

If Kreepy Krauly is moving too fast.

In most pools, the automatic regulator valve supplies Kreepy Krauly with the proper amount of water flow. However, if used with an especially powerful pool pump, the valve can be overpowered.

- To slow Kreepy Krauly down, a manual by-pass valve (Part #K12094) accessory is available for purchase from your Pentair Pool Products dealer. This manual by-pass can be adjusted to achieve the recommended cleaner speed of 8 to 12 feet per minute.
- To decrease the speed of Kreepy Krauly, simply remove the in-line valve cone from the bottom of the automatic regulator valve and replace it with the manual by-pass as shown in Figure 15.
- Press the automatic regulator valve into the threaded compression adapter (or 2" hose cone if used). The end of the valve that is marked "Attach Hose This End" must point up.
- Adjust the manual by-pass while the Kreepy Krauly is running. Place your hand into the skimmer and turn the by-pass adjuster one click at a time until the desired speed of 8-12 feet per minute is reached. See Figure 16.

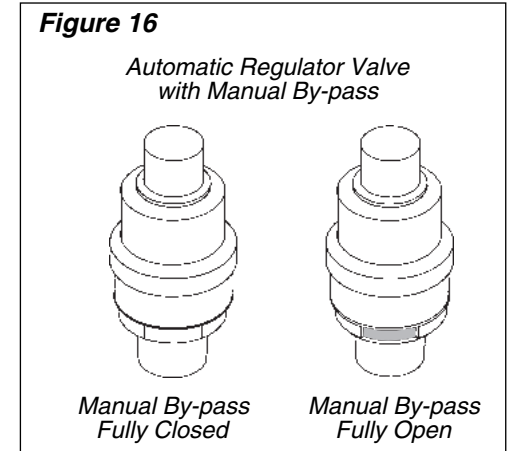
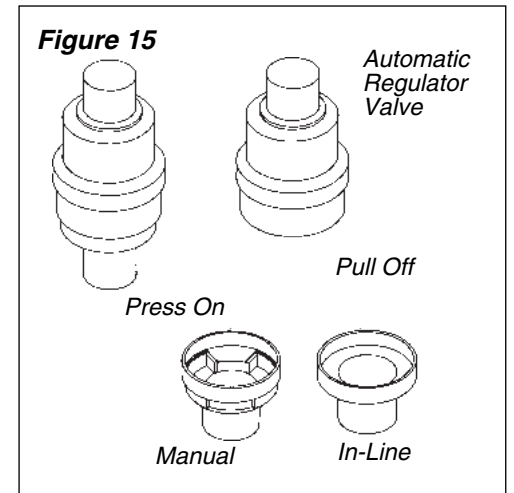

If Kreepy Krauly pulls air from, or remains at, the water surface.

- Check to ensure the dive float mechanism is operating freely and the dive float restrictor is installed. (See page 4 for how to install dive float restrictor.)
- Check the automatic regulator valve for its proper installation and ensure it is not clogged with debris.
- Make sure the water level is at least 3 inches below the pool deck.
- Check to ensure your Kreepy Krauly is operating at the proper speed of 8-12 feet per minute.

If Kreepy Krauly stays at the shallow end steps.

- Check the return line water flow and redirect as necessary with an eyeball diverter. Refer to page 9.
- Check the automatic regulator valve for its proper installation and ensure it is not clogged with debris.
- Check that hose is long enough to reach the furthest point of the pool, including pool steps. Refer to page 8.
- Check that Kreepy Krauly has proper hose balance in shallow end. Refer to page 8.
- Check to ensure your Kreepy Krauly is operating at the proper speed of 8-12 feet per minute.
- Check to ensure the dive float mechanism is operating freely and the dive float restrictor is installed. (See page 4 for how to install dive float restrictor.)
- Shorten the roller bumper strap by 1/2 inch. (Pull out upper end of bumper strap from locking end clip attached to swivel head. Cut 1/2 inch off, then return bumper strap into locking end clip.)

V. Troubleshooting

Because of the individual characteristics of your pool, some additional adjustments may be required to get the best performance from your Kreepy Krauly.

If there seems to be a problem, check these common causes of cleaner problems. If you still need help, call your pool professional or call our toll-free **Customer Helpline at 1-800-443-5711**.

— Is bottom main drain closed?	Close drain
— Is filter clean?	Clean filter
— Is pump strainer basket clean?	Clean basket
— Is debris blocking the bottom of Kreepy Krauly?	Remove debris
— Are there any leaks in the hose?	Replace leaky section
— Is automatic regulator valve free of debris?	Clean valve

If Kreepy Krauly is not moving or not pulsating.

- Check to ensure that the main drain and **all** suction lines are closed, *except* for the suction line to which Kreepy Krauly is attached.
- Check for debris in the filter or pump basket.
- Check for debris in Kreepy Krauly's flapper. Debris may prevent flapper movement or restrict flow. See page 13 for instructions.
- Pool pump and filter system may be too small (incapable of providing 25 gallons per minute water flow). Consult your pool professional.

If Kreepy Krauly stays in one end of the pool.

- Check the return line water flow and redirect as necessary with an eyeball diverter. Refer to page 9.
- Check that hose is long enough to reach to end of pool. Refer to page 8.
- Check that Kreepy Krauly has proper hose balance. Refer to page 8.

If Kreepy Krauly stays on the main drain.

- Check to ensure that main drain is closed. A pool professional may need to assist you.
- Check to ensure that a main drain grate is installed.
- If main drain is not flush with the pool floor, consult your pool professional.

If Kreepy Krauly slows or stops and air bubbles enter the pool at the return line.

Find and correct the air leak that is causing the pump to lose its prime:

- Check the hose to ensure there are no leaks.
- Check the vacuum connection. It should be submerged so no air enters the system.
- Check the pump basket lid for looseness, cracks, and worn or missing O-rings. If you need assistance, contact your pool professional.

Optional Vacuum Line Installation *Vacuum Line Installation With Automatic Regulator Valve in Skimmer.*

We recommend the use of the automatic regulator valve to balance water flow between Kreepy Krauly and the skimmer. When attaching Kreepy Krauly to a dedicated vacuum line, the automatic regulator valve should be installed in the skimmer.

Accessories NOT PROVIDED:

- Snap-Lock Wall Fitting NSF (Part #GW9530)
- 45° Hose Connector (Part #K12078)

1. Turn the pool pump off.
2. Close the main drain and all suction lines, except the skimmer and the vacuum line to which the Kreepy Krauly will be connected.
3. Thread the snap-lock wall fitting into the end of the dedicated suction line. Then insert the male end of the 45° hose connector into the snap-lock fitting. See Figure 10. **NOTE: Use two wraps of Teflon tape around the threads to ensure easy removal.**
4. Place Kreepy Krauly (with the hose and hose weights assembled and attached) into the pool and allow it to sink to the floor. **NOTE: You will have to remove the female/female hose section in this installation.** Continue to feed the hose vertically down into the pool until it is completely filled with water and purged of air.
5. Insert the male hose end of the last hose section into the 45° hose connector or directly into the snap-lock wall fitting. **Reminder: Do not use the female/ female hose section in this installation.** See Figure 10.
6. Screw the threaded compression adapter into the vacuum connection in the bottom of the skimmer. **NOTE: Use two wraps of Teflon tape around the threads to ensure easy removal.** If the opening in the bottom of the skimmer is **not** threaded, use a 2" hose cone, the 2" hose cone is not provided but can be purchased from your Pentair Pool Products dealer.
7. To prevent water from flowing through the top of the automatic regulator valve, fasten the valve cap onto the top of the regulator valve. This activates the regulator valve and assures that an accurate amount of water (25 gpm) will flow through the vacuum line and the Kreepy Krauly. Without the valve cap, the automatic regulator valve and the cleaner will **not** function properly. See Figure 12.
8. Press the automatic regulator valve into the threaded compression adapter. See Figure 12.

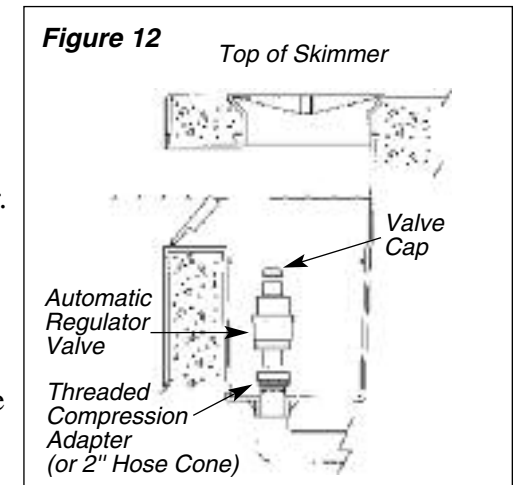
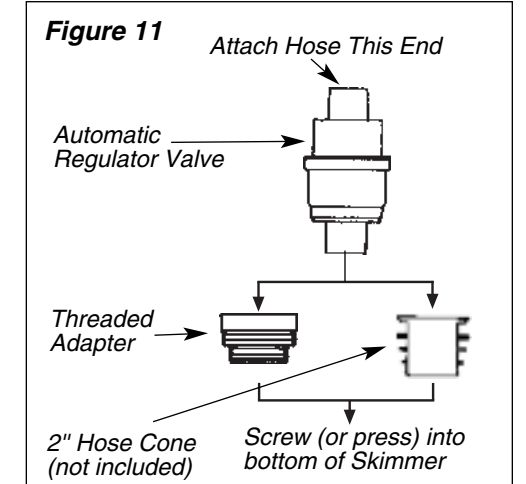
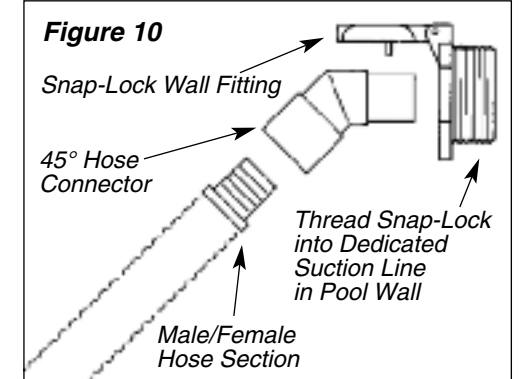

IV. Adjustments

After completing the installation, **turn the pool pump on**. Allow the pump to run for a couple of minutes to ensure all air cycles out of the system. Kreepy Krauly should be moving about the pool at a rate of 8 to 12 feet per minute. Check each of the following initial adjustments to Kreepy Krauly at this time.

Hose Length

IMPORTANT: The pump must be on when you check the hose length. The hose contracts when the pump is operating and will be longer when the pump is off.

With Kreepy Krauly operating, position it at the furthest point of the pool from where it's attached. (It is easy to position Kreepy Krauly in the pool by moving it about with your pool pole and brush.) Kreepy Krauly's hose should be long enough to reach the end of the pool, plus one hose section. If necessary, remove extra hose sections from the center portion of hose. Removing center hose sections avoids having to disturb the hose weight placement. Save extra hose sections for use as needed for replacement.

NOTE: Turn pool pump off when adding or removing hose sections.

Hose Balance

To determine correct hose balance, **turn the pump off** and observe Kreepy Krauly. Hose balance is correct when Kreepy Krauly's seal rests flat on the pool floor and the drive tubes make a 45° angle with the floor, as shown in Figure 13. Kreepy Krauly achieves the best cleaning coverage when the hose neither weighs down nor pulls up on the unit. Adjust hose weights one inch at a time as needed, until proper hose balance is achieved. In pools with both shallow and deep areas, adjust hose weights first in the deep area and then in the shallow area.

1. **Hose Too Light.** If the hose rises toward the surface at an angle greater than 45°, move the weights closer to Kreepy Krauly, or move the first two weights closer to each other.
2. **Correct Hose Balance.**
3. **Hose Too Heavy.** If the hose sags downward at an angle less than 45°, move the weights away from Kreepy Krauly, or separate the first two weights away from each other.

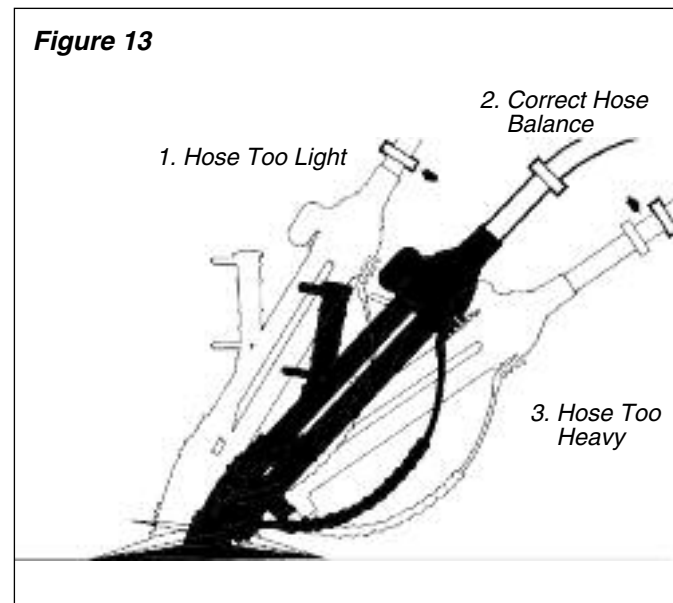

Figure 13

Return Line Water Flow

IMPORTANT: The water flow from your return line can push Kreepy Krauly's hose and affect its performance. It may cause Kreepy Krauly to steer away from the end of the pool where the return line is located, or it may cause Kreepy Krauly to remain in one section of the pool. To correct this, use the eyeball diverter included with your Kreepy Krauly. (If the eyeball does not fit your pool, use the wire diverter (Part #K121620) accessory available for purchase from your Pentair Pool Products dealer.)

To install the eyeball diverter:

- First make sure your **pool pump is off**. Remove the original eyeball from the return line at the pool by unscrewing the lock ring.
- Replace the original eyeball with the Kreepy Krauly eyeball diverter.
- Replace the lock ring and tighten. Make sure the opening of the eyeball diverter points in the proper direction before tightening fully. See "Eyeball Diverter Positions" below.

Figure 14

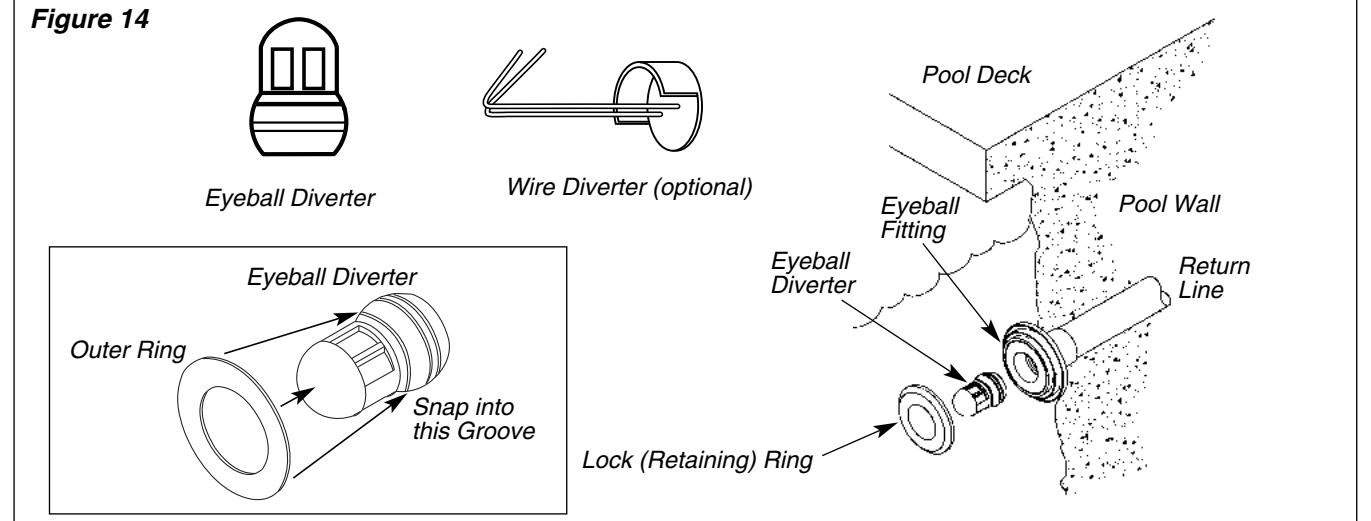

IMPORTANT: The eyeball diverter must fit snugly into the eyeball fitting. Some eyeball fittings, like Aqua Leader or Olympic, may be too large for the eyeball diverter. In this situation, use the outer ring supplied with your Kreepy Krauly to adjust for the discrepancy in size.

- Snap the outer ring onto the eyeball diverter and position it in the first groove as shown in Figure 14.
- Insert the eyeball diverter/outer ring assembly into the eyeball fitting in the return line.
- Install the lock (retaining) ring and tighten. See Figure 14.

Eyeball Diverter Positions

Position the diverter opening to redirect the return line water flow so it does not interfere with Kreepy Krauly's movement. Try different positions to see which works best in your pool:

- flow directed along the side of pool (the tile line).
- flow directed downward.
- flow directed against the hose will help steer Kreepy Krauly **away** from obstructions such as stairs and ladders.

After installing the eyeball diverter, **turn the pool pump on**. Kreepy Krauly should begin moving across the pool floor vacuuming up debris in its path.